

FWB1321-J

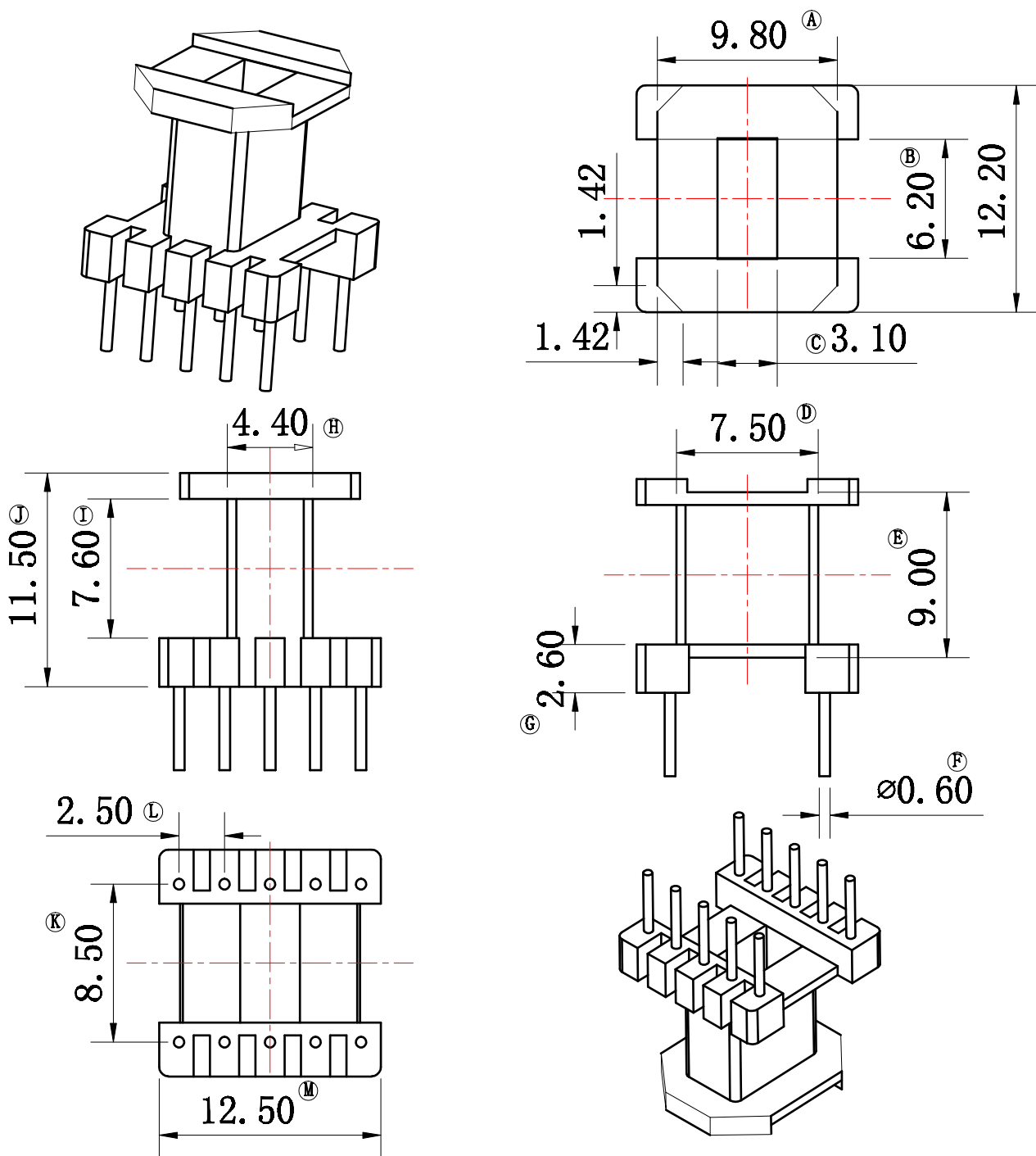

REV	REVISION RECORD	DATE	REV	REVISION RECORD	DATE
A			C		
B			D		

NAME	EE13 5+5P	MATERIAL	PHENOLIC	SCALE		ANGLE	$\pm 1^\circ$
DRAWING NO.	FWB1321-J	PIN MATERIAL	CP WIRE	UNIT	m/m	REV	A
TOLERANCE OF PIN PITCH	± 0.20		HAINING FERRIWO ELECTRONICS CO.,LTD.				
PIN TENSION LOAD	kg MN	UL REC: 94V-0	TEL: +86-573-87088701 FAX: +86-573-87081130				
TOLERANCE:	0<L≤4: ±0.2	4<L≤16: ±0.3	16<L≤63: ±0.4	Web: www.ferriwo.com Email: sales@ferriwo.com			